

MARIETTA
COLLEGE
BRAND
GUIDE



Marietta College

table of contents

WHAT IS A BRAND?	3
THE MARIETTA BRAND	5
THE CORE OF OUR BRAND	5
POSITIONING	8
PERSONALITY	8
THEME	9
OVERVIEW MESSAGING	9
EDITORIAL TONE AND CONTENT	11
PERSONALITY	14
BRAND MESSAGING	16
USING THE BRANDING THEME	18
MESSAGING BY AUDIENCE	19
PROGRAM-SPECIFIC MESSAGING	30
DESIGN AND VISUALS	33
VISUAL IDENTITY GUIDELINES	45
LOGOS	46
COLORS	54
RECOMMENDED TYPE STYLES	64
ATHLETICS LOGO	66
LICENSING AND TRADEMARK ENFORCEMENT	83
CONTACT	91

WHAT IS A BRAND?

A brand is a feeling.

A brand is the identity of an organization—what it delivers everyday as well as what it stands for in the hearts and minds of its audiences.

Effective brands connect the truth of who they are with what their audiences value. They have a personality and a position that set them apart.

A brand is not a logo, or a mission statement, or a set of core values—although these do inform the brand.

It is who you are.

When everything an organization does supports its brand—and when a brand’s look, feel, tone and messaging are consistent throughout all communications—a brand can have enormous power.

This brand guide will help everyone at Marietta College harness that power.

THE MARIETTA BRAND

Bring Forth a Pioneer.

This is the time. This is the place.

The Marietta College brand is the story that both College and student create together. The way we express our brand through design and editorial—the feeling we evoke—dynamically highlights who we are and who we aspire to become.

THE CORE OF OUR BRAND

The Marietta College brand story can be distilled to three essential elements:

- — ○ THE PIONEER SPIRIT OF OUR PEOPLE
- ||| THE SPACE WE OFFER TO EXPLORE
- || ○ → THE NEW FRONTIERS WE OPEN THROUGH OUR PROGRAMS



FO



BRING RTH A PIONEER

POSITIONING

A brand positioning statement is an internal touchstone to guide communications. It clearly defines how we differentiate ourselves from other colleges and universities and the value we bring to students and our community.

At Marietta College, driven, independent people join together in an expansive learning environment with leading-edge liberal arts and professional programs to create a transformative experience that enables students to boldly shape their future and the world.

PERSONALITY

Every brand has a personality, a way that we can reflect its identity in human terms. These attributes should guide the tone of all Marietta College communications.

Independent

Connected

Driven

Creative

Adventurous

Inspiring

Bold

Transformative

THEME

Marietta College’s branding theme is a call to action that communicates who we are in a distinctive way. It provides a framework for engaging all audiences with our value and mission.

It is a rallying cry, a specific call to the next generation of Marietta students—as well as a call for the current Marietta community and The Long Blue Line to unite. It asks all to draw upon their inner pioneer, connecting the College’s rich history with its resiliency and ability to provide an exceptional education.

BRING FORTH A PIONEER.

OVERVIEW MESSAGING

What does it mean that Marietta is a small, contemporary liberal arts and sciences college?

That relationships matter. That students gain top-level skills that employers value. That undergraduates and graduate students alike find their calling and make a difference—on campus and wherever they venture from here.

EDITORIAL TONE AND CONTENT

All editorial content and tone should reflect Marietta College's brand personality and positioning.

In marketing communications and advertising editorial, strive for clarity and impact. Strive for thought-provoking headlines that differentiate Marietta College and draw readers into the story. Avoid institutional language that is not meaningful to the audience.

Compelling, well-told stories communicate the brand more effectively than facts and figures or lengthy explanatory text. Make efforts to highlight key points through powerful true stories told through a blend of captivating video, audio, text and photos.

EDITORIAL STYLE

Marietta College communications follow the most current edition of The Associated Press Stylebook. (This does not include scholarly publications, which follow relevant academic style guides.)

EXPL



TH

UNKN



LORE



HE



HOWN.



PERSONALITY

Every brand has a personality, a way that we can reflect its identity in human terms. These attributes should guide the tone of all Marietta College communications.

When writing copy and headlines, use a tone that is bold and inspiring, appealing to the independent spirit but always with our collaborative nature in mind—a tone that brings to life the Marietta brand personality.

Independent

Pioneers are self-reliant, original thinkers.

We are not content to follow the crowd—in fact, we thrive on the challenge of blazing a new trail.

Driven

Pioneers are hardworking individuals who want to give back.

Adventurous

Pioneers seek adventure.

We challenge ourselves to explore every new opportunity, push beyond what we thought we could do and live fully in the moment.

Bold

Pioneers lead the way.

We think boldly and act for impact, whether it's creating a nationally recognized academic program, winning a championship or harnessing our leadership and analytical skills to shape our careers and communities.



**Marietta isn't for those
who are content to follow.**

Connected

Relationships matter to Pioneers.

We create a collaborative culture deeply rooted in our responsibility to each other and to the world.

Creative

Pioneers are innovative and entrepreneurial.

We believe an understanding of the arts, humanities and sciences is essential to an expansive life and a problem-solving mindset.

Inspiring

Pioneers dream big.

We believe that we can discover our calling and translate it into a career, that we can do and be more, that we can make a difference in the world.

Transformative

Pioneers put their dreams into action and achieve more than they ever imagined.

BRAND MESSAGING

When telling the Marietta College brand story, keep in mind the essential elements of our messaging: the pioneer spirit of our people, the space we offer to explore and the new frontiers we open through our programs. Consider these elements when writing copy; they help articulate our positioning and tell Marietta stories in a way distinctive from other colleges and universities.

THE PIONEER SPIRIT OF OUR PEOPLE

Pioneers are driven and independent—and know that together they can accomplish anything.

- We are hardworking students, faculty and staff, with a work ethic, intellectual curiosity and drive to give back.
- Students, faculty and staff are genuinely connected. Every single student works individually with a faculty mentor in a capstone project and experiences a culture of interaction with all Marietta community members that changes his or her life.
- We are The Long Blue Line of successful, proud and loyal graduates who stand ready to inspire the next generation of Marietta students.
- We respect diversity and celebrate a global perspective.

THE SPACE WE OFFER TO EXPLORE

With space to seek adventure, Pioneers will thrive.

- Our campus provides the technology and resources for students, faculty and staff to pursue their interests.
- Our campus and surrounding community provides a safe place for students to take the intellectual risks that expand their knowledge of the world.
- Our location between two rivers amid Appalachia's natural beauty provides boundless opportunities to enjoy the outdoors, and the region's pioneer history and contemporary culture provide other expansive opportunities to stretch students' experiences.

THE NEW FRONTIERS WE OPEN THROUGH OUR PROGRAMS

Pioneers always lead the way.

- We put a modern spin on the classic liberal arts education. Extensive experiential learning, professional opportunities and integrated leadership training allow students to apply the broad knowledge and in-demand skills gained from studying the arts and sciences.
- We are a leader in petroleum engineering, land management, teacher education and more, and offer exceptional opportunities and nationally accredited programs in a wide range of academic fields.
- The result is graduates who open new frontiers in their futures and in their fields.

USING THE BRANDING THEME

BRING FORTH A PIONEER.

Marietta College’s branding theme is a call to action that communicates who we are in a distinctive way. It provides a framework for engaging all audiences with our value and mission.

The theme is a rallying cry, a specific call to the next generation of Marietta students—as well as a call for the current Marietta community and The Long Blue Line to unite. Variations of the theme pair with phrases such as “This is the time. This is the place.” to tailor the message to specific audiences and create a sense of immediacy. Whether speaking to high school students or potential donors, with this theme we are calling audiences to act and promising that here is where that action will have the greatest impact.

The use of “Pioneer/pioneer” connects Marietta College’s rich history, long line of successful alumni and powerful athletics with the exhilarating promise of all that the College, and those connected with it, can and will do.

MESSAGING BY AUDIENCE

Within Marietta College’s brand “voice,” the attributes of our brand personality can be dialed up or down to craft copy that resonates with different audiences. Think of these attributes as volume controls.

For instance, when writing for an audience of young potential undergraduate students, the tone and style should connect with their desire for originality (Independent) and exciting new challenges (Adventurous). When addressing their parents, the tone and style should be more practical (Driven) and outcomes oriented (Transformative).

The following sections highlight the messaging emphasis and give an editorial example for many of Marietta College’s primary audiences: prospective undergraduates, prospective athletes, parents, prospective graduate students, alumni, donors, faculty and staff.

When crafting your message, first step back to consider your audience’s needs so that you can shape effective, authentic communications that meet these needs. Ground your message in current beliefs and future expectations to build credibility and inspire your audience to action.



TAKE A

ROAD

An aerial photograph of a large brick building with a prominent white clock tower. The tower has a square base with a window, a clock face, and a smaller square top with a balcony. The building is surrounded by lush green trees, some with autumn-colored leaves. In the background, a cityscape and a bridge are visible under a clear sky.

TRIP.

SPEAKING TO POTENTIAL UNDERGRADUATES

Today's Generation Z possesses a strong desire to better the world, and many are hopeful their personal interests will translate into careers. While they value a college degree, they are concerned with cost. The theme speaks to both the practical impact that choosing Marietta will have on them as well as the impact they will make as they go forth from Marietta.

By blending a soaring, lyrical feel and bold ideas, editorial will appeal to all genders of students to help achieve the gender balance the College seeks.

MESSAGING EMPHASIS

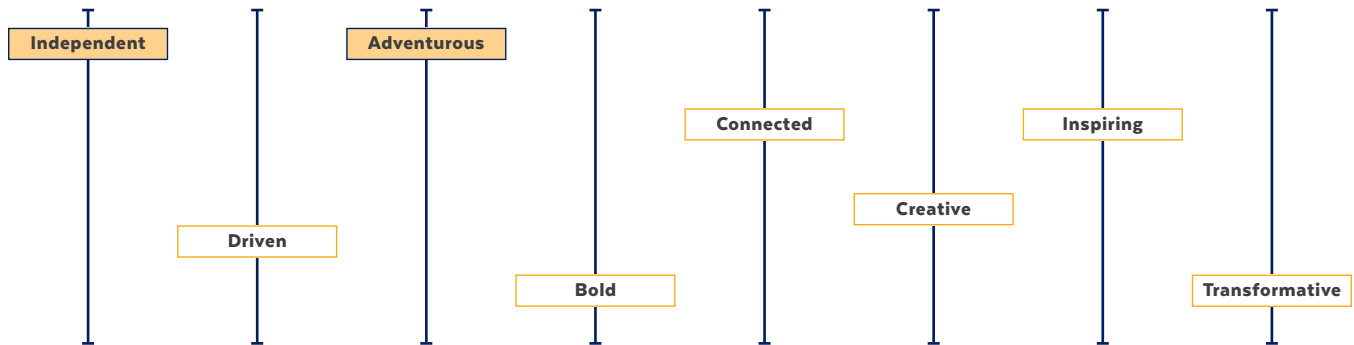

EDITORIAL EXAMPLE

Have you heard what happened to those with curious minds?

They packed up. They got out. Broke free of conventions.

And, oh, you won't even find them on the path less traveled. These prospectors of knowledge, these nonconformists, are blazing a new trail. A course that confronts challenges. With the sole purpose of defeating them.

They never fall in line. But they are joining the long line of those who sought adventure, explored the unknown and prepared for anything.

Breathe. Let go.

Hear the voice inside you. It's calling. An undeniable desire to seek answers and the tenacity to put them to good use.

Sing the song of your mind.

**This is the time. This is the place.
Bring forth a Pioneer.**

SPEAKING TO PROSPECTIVE ATHLETES

With the College’s electrifying Ohio Athletic Conference competition and mounting list of national championships, DIII athletes will have powerful opportunities as Marietta Pioneers.

MESSAGING EMPHASIS

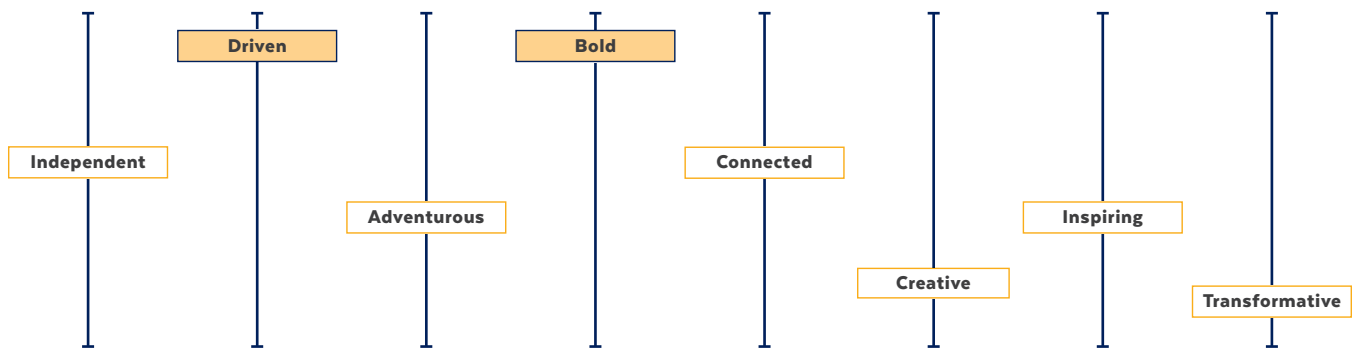

EDITORIAL EXAMPLE

**It’s just like a Pioneer to rise to the challenge.
You’ve worked hard. And at Marietta, it will pay off.**

Not just as part of a team that wins the championship in the Ohio Athletic Conference, but as part of a school where every student and professor will challenge you to reach inside and go further and faster than you imagined you could.

It’s time.

SPEAKING TO PARENTS

For cost-conscious families, and particularly for the parents of the many first-generation college students that Marietta attracts, the theme creates an exciting opportunity to explain the value of a liberal arts education to prospective families by emphasizing the immediate need for critical thinkers, problem solvers and well-rounded individuals.

MESSAGING EMPHASIS

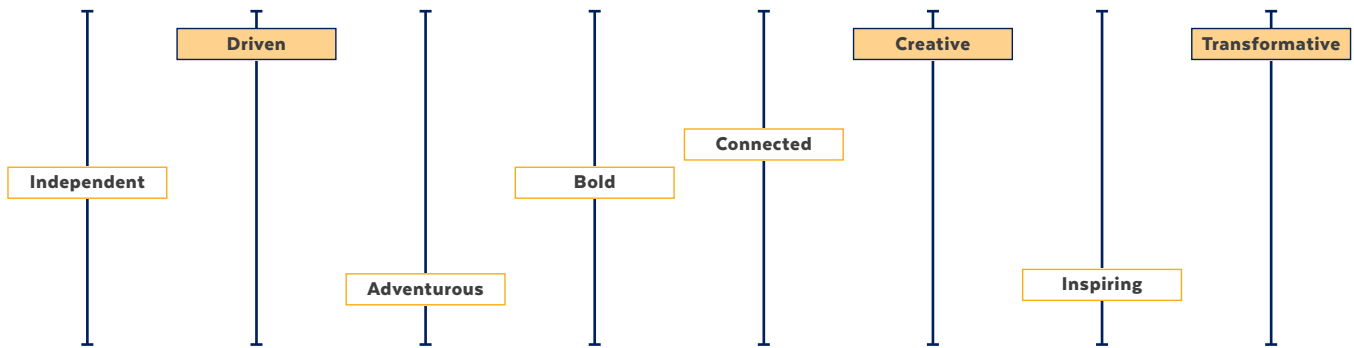

EDITORIAL EXAMPLE

This is the time. This is the place.

Today’s employers in all fields are seeking innovative problem solvers and strong thinkers who can advance their organizations. They seek leaders ready to tackle any challenge.

Marietta College prepares those leaders.

We help students pursue big ideas, apply them to real life and turn what they care about into a career. Along the way, our professors and alumni connect students to a professional network throughout the country and across the world.

When it comes to lifelong opportunity, Pioneers always lead the way.

SPEAKING TO PROSPECTIVE GRADUATE STUDENTS

A master's degree from Marietta College opens a path to career success and the ability to make a real impact on others through one's profession.

MESSAGING EMPHASIS

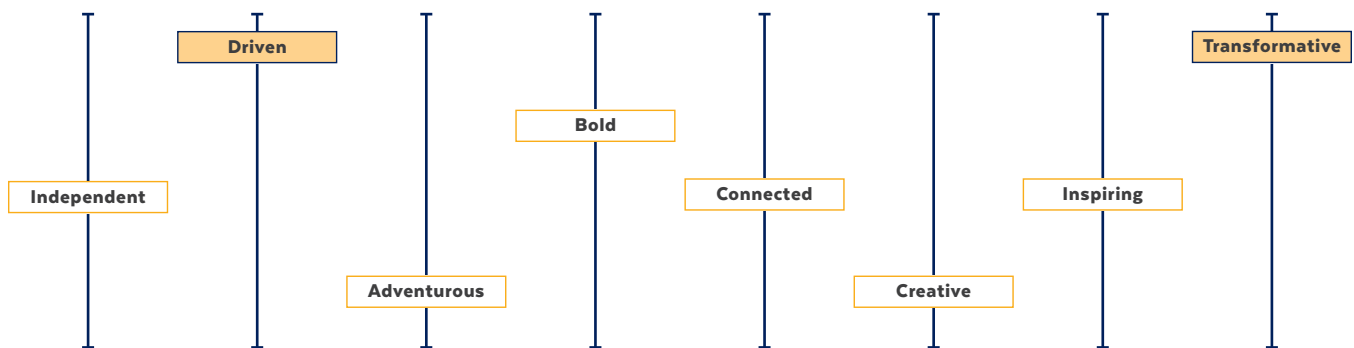

EDITORIAL EXAMPLE

If you're seeking maximum impact on your career and your community, Marietta College is the place.

Our graduate-level Physician Assistant Program will prepare you to meet the dramatically rising need for quality healthcare in our region and throughout the country. The physician assistant profession is one of the fastest-growing occupations in the nation. Forbes and USA Today have named it the most promising job in America.

At Marietta, close collaboration with talented professors, along with extensive research and clinical opportunities, will energize you and prepare you in every way. Our students consistently surpass the national graduation rate and first-time pass rate on the Physician Assistant National Certifying Examination. Nearly all obtain immediate employment, with more than two-thirds practicing in Ohio and the Appalachian region.

Think boldly. Act for impact. As a Pioneer, your potential is unlimited.

SPEAKING TO ALUMNI

The theme allows alumni to reflect on their own years at Marietta College with nostalgia and appreciation for how the College shaped their future. It builds on the pride and loyalty of The Long Blue Line to instill a desire to connect with and support the College, helping their own in times of both need and strength.

MESSAGING EMPHASIS

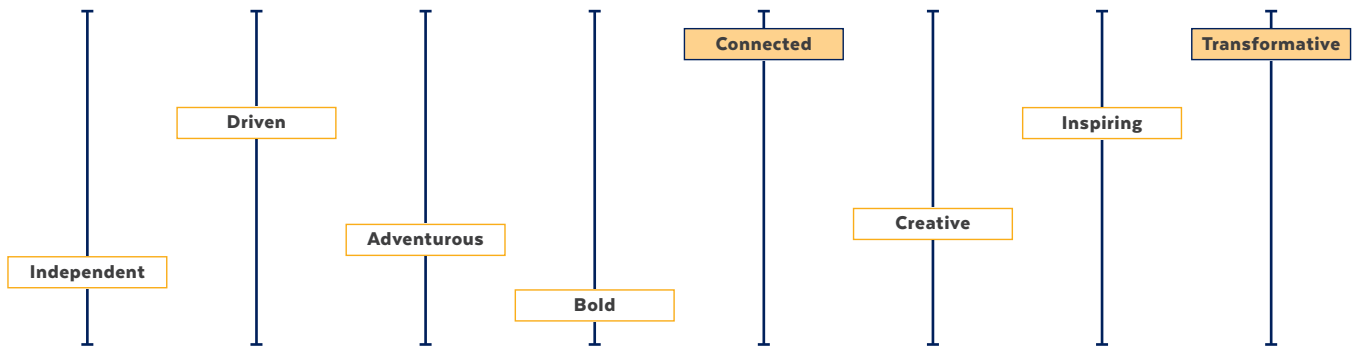

EDITORIAL EXAMPLE

We are Pioneers and our time is now.

We are expanding the frontiers of science, art, education. We are giving back and forging ahead. We are readying the next generation of adventurers who seek to blaze new trails.

Together we can do anything.

**You are The Long Blue Line.
We want you to be part of its future.**

SPEAKING TO DONORS

Through their support of Marietta College, donors will directly impact talented, hardworking students who will, in turn, positively impact their professions, their communities and the future.

MESSAGING EMPHASIS

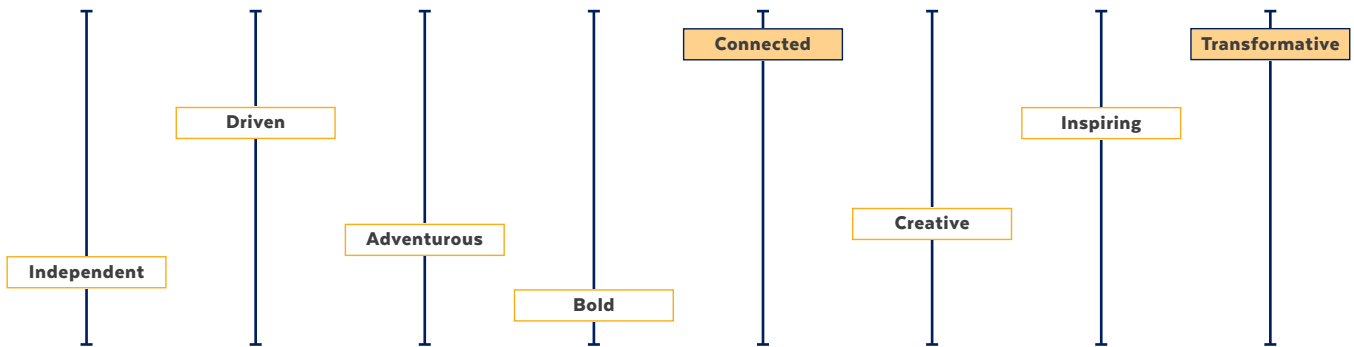

EDITORIAL EXAMPLE

The world needs Pioneers.

Bold thinkers ready to confront any challenge. Independent spirits able to inspire and lead others on the journey to a promising future.

It takes all of us to prepare the next generation that will go forth from Marietta. This is the time. This is the place.

With your help, we will continue to bring forth Pioneers.

SPEAKING TO FACULTY AND STAFF

Small, liberal arts colleges draw faculty and staff who value teaching and their relationships with students. The theme allows the College to highlight the transformative impact prospective faculty and staff will have as they pursue their professional careers in Marietta’s highly collaborative, interactive culture.

MESSAGING EMPHASIS

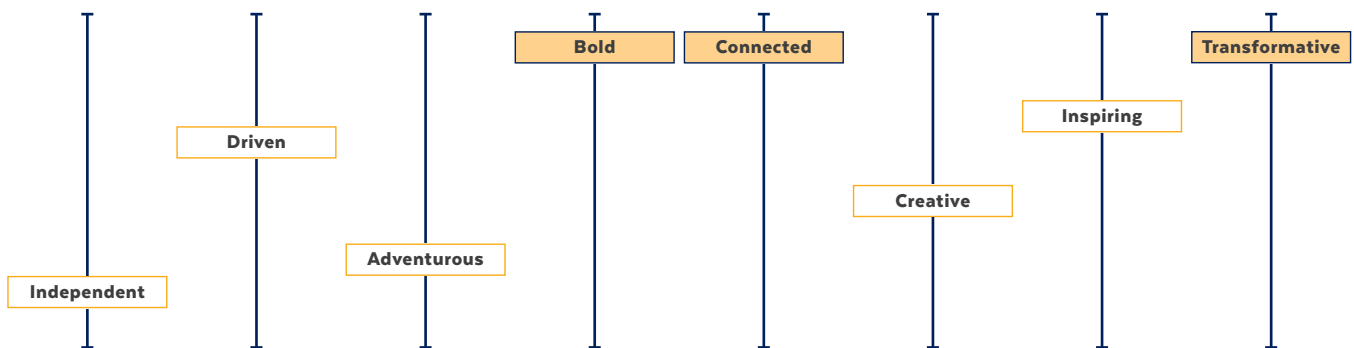

EDITORIAL EXAMPLE

At Marietta College, great work has greater impact.

As you expand the boundaries of your field, you will open new possibilities to students with the drive and independent spirit to make a difference wherever they go. Finding our next Pioneers takes a Pioneer. Our highly collaborative culture inspires deep mentoring relationships that are truly life changing for our students.

Here you will find remarkable resources and an environment inspired by the energy of colleagues who dedicate their expertise to creating innovative, nationally recognized programs.

Here you will harness the practical power of a liberal arts education.

PROGRAM-SPECIFIC MESSAGING

To engage audiences with the Marietta College brand and support our brand positioning in marketing communications and advertising editorial, it is important to present the College as a whole and highlight our strongest programs. Content should be strategically chosen to support our essential brand elements, which often for communications produced by the College means emphasizing Marietta College overall and its leading programs. At the departmental level, it means selecting specific content that illustrates the pioneer spirit of our people, the space we offer to explore and the new frontiers we open through our programs. Communicating the brand effectively in this way will help us reach our overall admissions and advancement goals, thus strengthening all of our departments.

In developing editorial for specific programs, keep in mind Marietta College's branding theme and essential messaging elements as well as the aspects of the brand personality that are most applicable to that program.

EDITORIAL EXAMPLE: PHYSICS MAJOR

Liquid nitrogen ice cream? Just one of the creative ways Joe Andler '15 helped promote campus science clubs and research while he was at Marietta. Joe interned at the National High Magnetic Field Laboratory through a Marietta alumni connection. He is now at Purdue working on a doctorate in materials engineering.

Major in physics or applied physics at Marietta and enjoy research opportunities that many students often wouldn't have until graduate school.

In small classes and independent projects, you will work closely with faculty who are dedicated to teaching and mentoring student research. You will use state-of-the-art facilities including a parallel computing cluster and quantum optics, scanning tunneling microscopy and surface physics laboratories. Marietta physics students earn NASA summer research fellowships, intern at Stanford, Johns Hopkins and Columbia universities, work in our planetarium and present their work at regional and national conferences.

EDITORIAL EXAMPLE: MANAGEMENT MAJOR

“Marietta gave me the excitement of learning new things every day; I always felt challenged. Taking courses that didn't directly align with my fields of study exposed me to different ways of thinking and enhanced my communication, analytical and reasoning skills.”

—Nathalia Ferreira '16, Account Representative, DHL Express

Marietta's broad range of courses and extensive opportunities for practical experience will help you prepare for a career in management in nearly any field you can imagine. In small classes and research projects, you will learn from faculty with significant international experience.

As a management major, you will help local businesses solve real problems. You can also connect with local entrepreneurs and social innovators in our PioPitch program. Or work on your leadership skills with experts at our McDonough Center for Leadership and Business.

DESIGN AND VISUALS

The Marietta College brand expression uses a variety of graphic elements to help convey the BRING FORTH A PIONEER theme and add a sense of forward motion and energy, including action-oriented graphics and design principles. While they may be used together, each creative execution should generally have only one visually dominating graphic element used with imagery.

Design and visual brand elements include:

- Upward diagonal lines
- “A to B” directional graphics
- Bold underlines
- Boundless and expansive layouts
- Dramatic photography and video of natural moments

An aerial photograph of a town at sunset. A wide river flows through the town, reflecting the golden light of the setting sun. The town is built on a hillside, with various buildings and streets visible. The sky is filled with soft, colorful clouds.

**This is
the time.**

An aerial photograph of a town at sunset. A wide river flows through the town, reflecting the golden light of the setting sun. The town is built on a hillside, with various buildings and streets visible. The sky is filled with soft, colorful clouds.

**This
is the
place.**

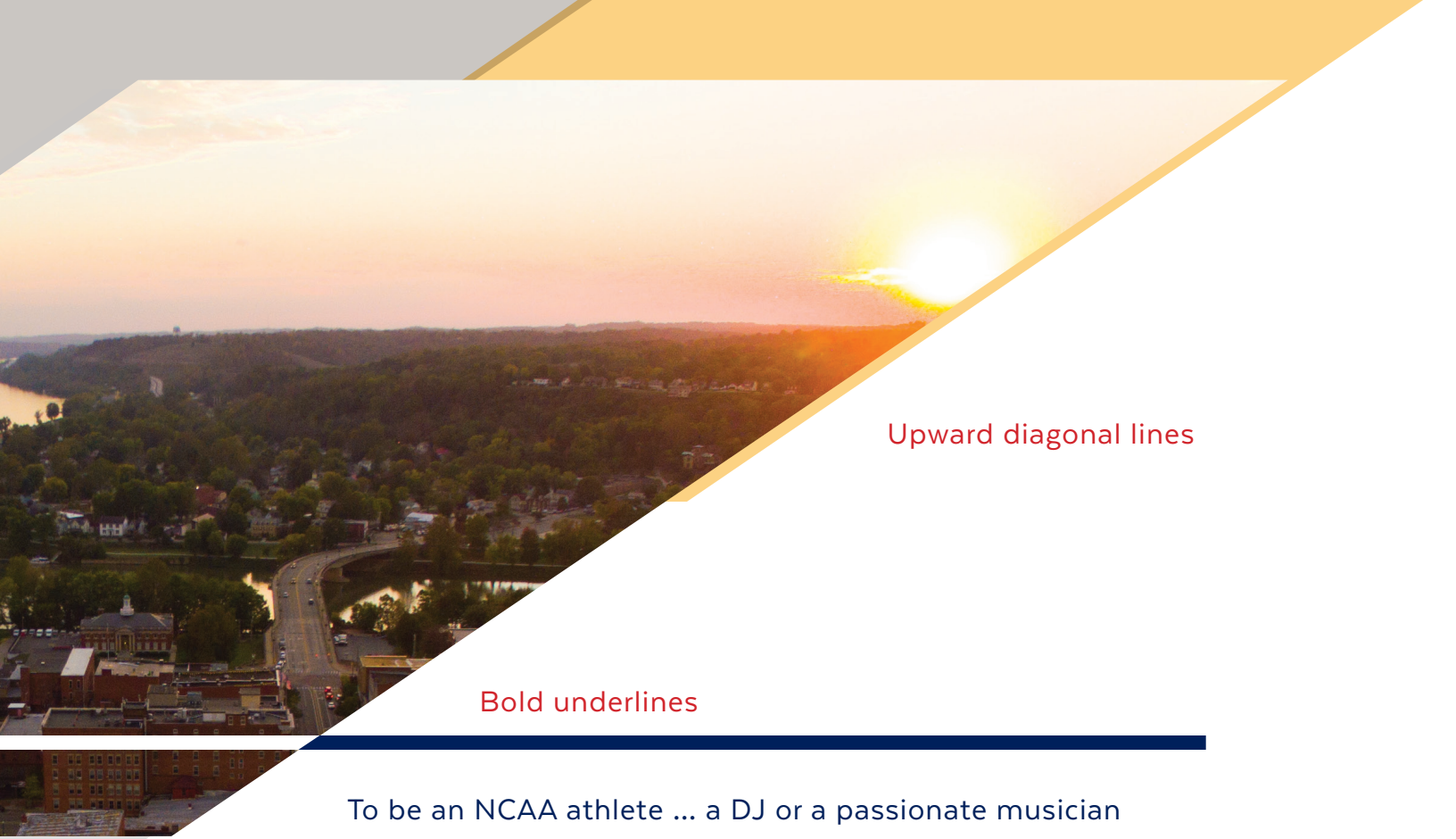

Upward diagonal lines

Underlines

To be an NCAA athlete ... a DJ or a passionate musician
... the leader of an innovative service project.

College is the perfect time, and Marietta is the perfect place, to discover all you can be and do.

When you come to Marietta, everyone will want you to join them, from the cast of the musical to the varsity crew team to the McDonough Leadership Program to the student-run TV station. With 95 percent of students living on campus—in traditional and apartment-style residence halls, fraternities and sororities—living and working with your best friends will be one of the best parts of the journey.

Dramatic photography and video of natural moments



UPWARD DIAGONAL LINES

Diagonal lines moving upwards suggest the idea of forward motion. Used over photography or as an accent, they should be offset with different beginning and end points. When used as a pattern on white backgrounds or connecting two boxes they should appear evenly cropped. Lines are set at a -55.25° angle.



**It's just like a Pioneer
to rise to the challenge.**

When upward diagonal lines intersect with a headline, the connecting font should be altered/cropped to follow the angle of diagonal lines.

CORRECT



INCORRECT



“A TO B” DIRECTIONAL GRAPHICS

The Pioneer spirit is visualized through “A to B” directional graphics. These lines, points and arrows become dynamic treatments for bullet points, connect key phrases or terms with imagery, and create letters within large headlines.

While their use is versatile, their style should remain consistent. In Adobe InDesign the start/end settings that may be used are “bar” (a simple line), “barbed” (a thin arrow), or “circle” (a simple circle). The angle of directional lines should not compete with any upward diagonal lines. Preferably, if the directional graphics and upward diagonal lines are used on the same page, they will be set to the same angle (-55.25) or contrasting angles (shown in the second example below, and in the example on page 39).



THE NEXT BIG IDEA IS YOURS. BECAUSE PIONEERS ARE ALWAYS FIRST.

As the starting point for adventurers for more than 175 years, it's only natural that Marietta College would have one of the finest entrepreneurship programs in the nation, supported by a committed network of faculty mentors and business partners.

Through our Summer Entrepreneurship Internship Program, you could receive a stipend of \$4,000 to support your work with entrepreneurs or entrepreneurial initiatives. Students have interned throughout the U.S. and abroad with private companies and nonprofits in fields including economics, public relations, graphic design, psychology, petroleum engineering and environmental science.

You can also compete for up to \$10,000 to support your new for-profit business venture in our PioBiz Competition, or connect with local entrepreneurs and social innovators in the PioPitch program. And students in any major can choose our minor in entrepreneurship.

- Never touched an instrument? ← Take guitar lessons.
- Decided on pre-med? ○—○ Add an art minor.
- Always been a swimmer? —||| Learn to rock climb.
- Never left the state? ||○—> Study in England for a semester.

THEY
PREPARED
FOR
ANYTHING



BOLD UNDERLINES

To add interest to a headline or emphasize a word or phrase within a headline, a thick underline can be used in combination with a boldface font. This underline should also be used to draw interest to a secondary graphic, like the logo or a subhead. This connecting element adds a sense of motion.



DRAMATIC PHOTOGRAPHY AND VIDEO OF NATURAL MOMENTS

The style of photography and video will add to the sense of exploration and the importance of living in the moment. The colors and lighting of scenes should be dramatic and warm and use the natural beauty of Marietta College's location and campus to highlight the expansive opportunities the College provides its entire community. These visuals should capture sincere moments of realization and fulfillment.

Most importantly, photography and video must be of professional-quality. The candid style should not be mistaken for low quality or point-and-shoot imagery or video.



USING FILTERS

Not every visual captures the emotion and setting as powerfully as intended. Filters may be applied to professional quality images or video that already capture an engaging scene, experience or individual, but may be more inspiring or dynamic with enhanced lighting and color. The primary use of filters should be to add warmth (Marietta's brand photography and video style) to a visual.

Filters should not overpower or take away from the subject and content of the image, or drastically change the natural colors of an image. Special vintage-style, bordered or era-specific filters are not appropriate.

Adjustments to professional photography and video should be made by qualified professionals with the Office of Strategic Communications & Marketing at Marietta College or approved vendors.

WITHOUT FILTER



WITH FILTER

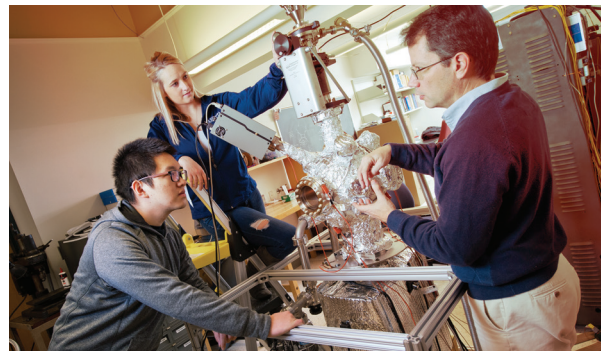
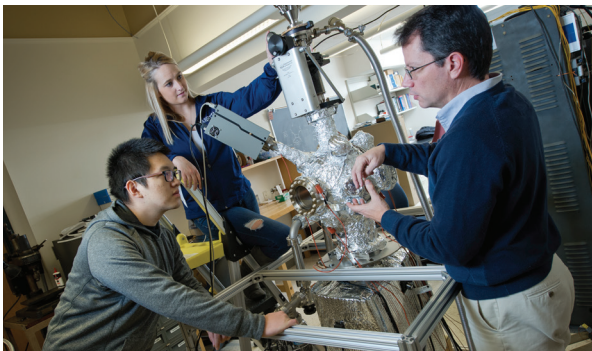

VISUAL IDENTITY GUIDELINES

The guidelines have been designed to be user friendly and to make your communication materials both attractive and effective. Each content section offers instant access to the information you need, including:

- Marietta College's official visual identity marks, including the College's logo, seal and athletics logos
- Guidelines for use of the College's official colors and typefaces
- Important trademark and merchandising information

MARIETTA COLLEGE VISUAL IDENTITY MARKS

Marietta College’s visual identity is based on a system of official graphic marks, coordinated to help the public easily identify the College and to promote Marietta’s distinctive assets and visibility among its many important audiences. The images depicted below are the official visual identity marks of Marietta College. To promote strength and consistency—and to protect important trademark registrations—use of these marks should adhere to the graphic standards outlined in this manual.

OFFICIAL MARIETTA COLLEGE LOGO



In the summer of 2006, the Marietta College President and Cabinet officially approved this logo to serve as Marietta College’s primary visual identity mark of the institution for use on its stationery package, merchandise and all printed and electronic publications. The “Erwin Tower” oval icon represents Marietta College’s history of commitment to academics and to its liberal arts foundation.

This logo has been used since the mid-1980s but had not until 2006 been “officially” designated as the logo of Marietta College.

LOGO USAGE

The Marietta College logo is the primary visual identity mark of the institution and is to be used on stationery, merchandise and all printed and electronic publications intended for off-campus use. The logo must always be printed in a one-color format. Acceptable colors are Marietta Blue (PMS 281 Coated, PMS 295 Uncoated), black, gray, metallic silver and white in a reverse-out application. The logo must be produced at 100% of the color—screening the logo is not an acceptable usage.

REPRODUCING THE LOGO



The Marietta College logo comprises carefully crafted, customized artwork and type. As such, the College requires that electronic files or camera-ready art be used to create all forms of communication. Any attempt to recreate the art, type or spacing and styling of the logo by desktop publishing or word processing will result in inconsistencies that will compromise the integrity of the logo.

LOGO SIZING

The recommended minimum reproduction size of the Marietta College logo is 3/4" in width. Reducing the logo further compromises the integrity of the icon and the readability of the wordmark.



TOWER ICON AND WORDMARK USAGE

The Marietta College Tower icon may be separated (or peeled apart) and used alone to represent Marietta College. The first option in any printing of the College logo would be to use the entire logo, but there are cases where the Tower icon may be used.



INCORRECT LOGO USAGES

To ensure visual consistency, promote recognition and preserve its trademark status, the Marietta College logo must not be altered in any way. The illustrations below demonstrate many, but not all, incorrect uses of the logo:



INCORRECT USAGE
Elements removed



INCORRECT USAGE
Shifting of elements



INCORRECT USAGE
Single-line logo



INCORRECT USAGE
Shifting of elements



INCORRECT USAGE
Shifting of elements



INCORRECT USAGE
Stretching or distorting



INCORRECT USAGE
Changing proportions



INCORRECT USAGE
Font substitution



INCORRECT USAGE
Rotating or angling



INCORRECT USAGE
Separate and screen icon



INCORRECT USAGE
Substitution of icon

OFFICIAL MARIETTA COLLEGE SEAL



The Marietta College seal is the official ceremonial mark of the institution. As such, it is reserved for more limited use than the logo.

Historically, institutional seals were used to authenticate official messages. Their design is purposefully intricate and descriptive. The College seal is reserved as the official ceremonial mark of the institution for usages such as official documents, diplomas, citations and special signature items. It SHOULD NOT be used routinely on print or electronic communications or merchandise. Use of the seal must be approved by the Director of Creative Services. To ensure consistency, the hands in the shield should not be used as a separate image, the artwork and text inside the seal should not be altered in any way, and all previous versions of the College seal should be retired from use.

INCORRECT SEAL USAGES

The illustrations below demonstrate many, but not all, incorrect usages of the seal:



Hand and Crest
used alone



Border of seal missing



Gray used
in background



Altered fonts



Altered artwork



Outdated artwork

FAUX MARIETTA COLLEGE SEAL



The Faux Marietta College seal is to be used only on products for merchandising that require a simplified version of the seal or do not meet the higher end product requirement of the College's official seal.

The Faux College seal should **ONLY** be used on merchandise and **NOT** official College communication.

OFFICIAL MARIETTA COLLEGE ATHLETICS LOGO



All athletic logos are reserved for the use of the Marietta College Department of Athletics, which has its own graphic standards to direct these logos' specific use.

You can find the standards for these marks located on page 62.

MARIETTA COLLEGE COLORS

The official colors of Marietta College are “Marietta Blue” (Pantone Matching System PMS 281 for coated paper and PMS 295 for uncoated paper) white and metallic silver. When metallic silver cannot be used, the alternative is PMS Cool Gray 3. All of the Marietta College visual identity marks (the logo, seal and athletic logos) must appear in their entirety in either Marietta Blue (PMS 281 coated, PMS 295 uncoated), black, gray, metallic silver or in white for reverse-out applications.

Since white is one of Marietta’s official colors, white paper is usually a better choice than off-white or colored papers for printed publications, and provides a white background when reversing out Marietta’s visual identity marks.

When ordering materials from a vendor (for example, shirts and mugs), asking for “navy blue” is acceptable.

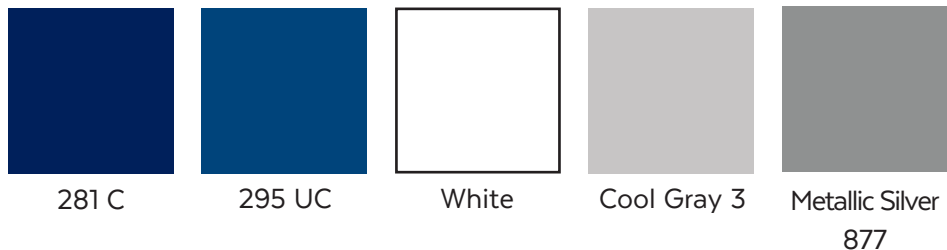

COLOR MATCHING

Correct vs. incorrect usages:



REVERSES

Readability and clarity are critical elements of Marietta's visual identity marks. Dark inks on light papers offer the best effect. Designers should take care that any use of a reverse-out effect offers a high contrast for maximum legibility. To reverse out of a photo or illustration, the area chosen for the reverse should be as dark and solid as possible, avoiding patterns that could make reading difficult (see example below). If PMS 281 or black are not used in your publication, reverse the visual identity mark in white from the darkest color.

Correct vs. incorrect reverse usages:



CORRECT USAGE
Reverse-out (PMS 295)



CORRECT USAGE
Reverse-out (Black)



INCORRECT USAGE
Outline of logo

Please Note: When printing a logo in a standard reverse, you must use the reverse logo. Adding an outline to the image will result in an incorrect usage.

Correct Reverse Usage



Incorrect Reverse Usage



PATTERNED BACKGROUNDS

All marks should not be used on patterned backgrounds if at all possible. If a question arises about the usability on a patterned background, please feel free to consult the Director of Creative Services about the logo usage.

HOT-STAMPING OR EMBOSSING

Designs that incorporate hot stamping or embossing of any of Marietta College's visual identity marks should be produced in conjunction with the Office of Strategic Communications & Marketing. Hot stamping and embossing options are generally limited to navy blue, black, silver or a blind emboss.

UNIT-SPECIFIC LOGOS

The Marietta College name and reputation are strong, and as such, they are an asset to entities on campus, a fact that reduces the need for individual unit-specific logos. The overwhelming majority of entities on campus are represented visually by the Marietta College logo, customized to the name of their individual entity as shown below. This unit-specific logo represents individual campus entities on all stationery, merchandise and printed and electronic communications. These entities include, but are not limited to:

- Administrative offices and their respective departments (i.e., those that report to the Office of the President, Provost, Vice Presidents, Deans and Directors)

Former logos or wordmarks previously used by these entities should be retired from use.

SAMPLE PROPORTION



“GRANDFATHERED” EXCEPTIONS

A limited number of individual campus entities are able to use their own logos or wordmarks, due to unique cultural or historical significance, funding provisions or an established strong identity with certain key audiences. However, to demonstrate a close connection to Marietta College, the College logo must also appear on the entity’s letterhead, merchandise and printed and electronic communications.

STUDENT-FUNDED CLUBS AND ORGANIZATIONS

Due to their nature and frequent changes in leadership, student clubs and organizations recognized by Marietta College and funded primarily by students may use their own logos and wordmarks when communicating with an on-campus audience. When communicating off campus, they must use the official Marietta College logo or the phrase “A Student Organization of Marietta College” in conjunction with their own logo or wordmark.

LETTERHEAD

Marietta College’s official letterhead may be ordered by contacting the Office of Strategic Communications & Marketing. Campus entities may order standard institutional letterhead, or letterhead customized for their individual school, office, department or program. To maintain consistency and professionalism in all College correspondence, individual campus entities or persons may not design their own letterhead.

ENVELOPES

The Office of Strategic Communications & Marketing coordinates an annual envelope order for all campus entities each spring, but will produce envelopes throughout the year as requested. Individual campus entities or persons may not design their own envelopes.

BUSINESS CARDS

To maintain a consistent and professional image for Marietta College, business cards may be ordered by contacting the Office of Strategic Communications & Marketing. Individual campus units or persons may not design their own Marietta College business cards. The only exception is the Marietta College athletic department, which follows its own visual identity guidelines.

CORRESPONDENCE STYLE GUIDELINES

To provide a more standardized, professional look for Marietta College correspondence, the College suggests that the letter begin at least 2” from the top of the page, with a 1” margin at both the right and left. A 1.25” margin should be set at the bottom of the page. It is suggested that correspondence should be printed in 11 point Arial (sans serif) or Times New Roman (serif) font.

ATHLETICS VISUAL IDENTITY GUIDELINES

All materials printed or produced by the Marietta College Department of Athletics, or in the name of Marietta College Pioneers, will adhere to the guidelines of the Marietta College Athletics Visual Identity.

The graphic elements contained in this guide are not to be altered in any manner and are reserved for use by Marietta College Athletics only. The Assistant Director of Athletics or Director of Creative Services must approve any exceptions.

- Individuals may not order any merchandise (clothing, stationery, etc.) that does not conform to these guidelines, including all items purchased/produced in-house or by third-party vendors.
- Apparel-related items may require additional guidelines.

Marietta College's athletics imagery is one of the most visible representations of the College's visual identity. In order to strengthen and maintain this image, the College has developed this guide to define specific, acceptable uses of athletics logos, images and fonts:

- When printing the names of individual teams and programs, the College's approved, specially designated type font must be used.
- Each of the images shown in this guide must appear in a horizontal and square position. No other format is acceptable.
- Use of any previous images, letterhead and other athletic design elements must be discontinued as new items are ordered.
- In accordance with all graphic standards and uniform guidelines, images shown are only a sampling of how the logos will be personalized to fit each athletic program.

MARIETTA COLLEGE VISUAL IDENTITY MARKS

Marietta College’s athletic visual identity is based on a system of official graphic marks, coordinated to help the public easily identify College athletics and to promote Marietta’s distinctiveness and visibility among its many important audiences. The images depicted are the official athletic visual identity marks of Marietta College. To promote strength and consistency—and to protect important trademark registrations—use of these marks should adhere to the graphic standards outlined in this manual.

OFFICIAL MARIETTA COLLEGE ATHLETICS LOGO



The primary Marietta College Pioneers athletic logo uses a stylized Interlocking MC. For the vast majority of applications, the primary logo is preferred and should be used. Where possible, print the entire image in Marietta College Blue (PMS 281 or PMS 295) and either Metallic Silver, 30% of PMS Black, or PMS Cool Gray 3.

WORDMARKS

“Marietta” is fully acceptable to be used as the secondary mark and is to be used when not using the primary logo.



MARIETTATM

The wordmark "MARIETTA" is rendered in a bold, italicized, sans-serif font. Each letter is filled with white and outlined with a thick blue border. The letters are closely spaced and have a slight shadow effect, giving them a three-dimensional appearance.

“Pioneers Word Logo”



PIONEERSTM

The wordmark "PIONEERS" is rendered in a bold, italicized, sans-serif font. Each letter is filled with white and outlined with a thick blue border. The letters are closely spaced and have a slight shadow effect, giving them a three-dimensional appearance.

ATHLETICS GUIDELINES

To assure that the logos are used correctly, the following guidelines have been established. Exceptions to the rules outlined below require approval of the Office of Strategic Communications & Marketing.

COLOR REPRODUCTION

The official colors of Marietta College are “Marietta Blue” (Pantone Matching System PMS 281 for coated paper and PMS 295 for uncoated paper), white and gray. When gray or metallic silver cannot be used, the alternative is 30% black. All of the Marietta College visual identity marks must appear in their entirety in either Marietta Blue (PMS 281 coated, PMS 295 uncoated), black, gray or in white for reverse-out applications.

Since white is one of Marietta’s official colors, white paper is usually a better choice than off-white or colored papers for printed publications, and provides a white background when reversing out Marietta’s athletic visual identity marks.

When ordering materials from a vendor (for example, shirts and mugs) asking for “navy blue” is acceptable.

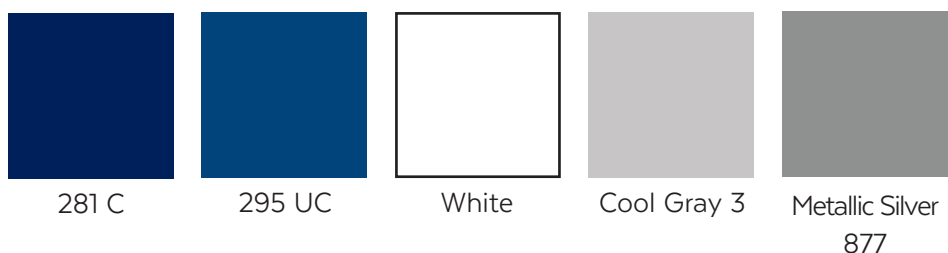

INCORRECT ATHLETICS LOGO USAGES

To ensure visual consistency, promote recognition and preserve its trademark status, the Marietta College logo must not be altered in any way. Please contact the Assistant Director of Athletics or Director of Creative Services before using logos.

PATTERNED BACKGROUNDS

All marks should not be used on patterned backgrounds if at all possible. If a question arises about the usability on a patterned background, please feel free to consult the Director of Creative Services about the logo usage.

SPECIALTY APPLICATIONS

Specialty applications of the logo (mugs, bumper stickers, T-shirts, decals, etc.) must be approved in advance by the Assistant Director of Athletics or Office of Strategic Communications & Marketing.

LOGO USAGE WITH OTHER SYMBOLS

Only the athletic logo or Marietta College logo is to be used on official college publications. Approval by the Assistant Director of Athletics or Office of Strategic Communications & Marketing is required.





















BASEBALL LOGO

Under the current Athletic Visual Identity, the Marietta College Baseball logo will be kept in use. The baseball MC will ONLY be used in references to the Marietta College baseball team. All color standards and identity standards will apply to the baseball MC.



SAMPLE SPORTS-SPECIFIC ART SHEET

Below is a sample of approved artwork for one of our sports. Each sport at Marietta College has an art sheet specific to that sport with approved art.

MARIETTA COLLEGE				
Established: 1855	Nickname: Pioneers	Conference: Ohio Athletic Conference		
Location: Marietta, Ohio	Mascot Name: Putnam	Current Revision Date: April 2023		
Uncoated Navy Blue	Coated Navy Blue	Flat Gray	Silver	White
PANTONE 295U	PANTONE 281C	PANTONE COOL GRAY 3	PANTONE 877	WHITE
BASKETBALL				
				
				
				
				

SPRING 2023

LICENSING AND TRADEMARK ENFORCEMENT

In the summer of 2012, Marietta College began a Licensing and Trademark Enforcement program. This program is a critical component of our overall branding initiative as Marietta College seeks to ensure the high quality and consistent standard of excellence for which it is known.

Any vendor creating merchandise (apparel, bags, writing utensils, mugs, etc.) bearing any of Marietta College's protected terms, whether for on-campus departments or organizations, or for third-party vendors to sell in stores, must be set up as an official licensee and go through an approval before placing the College's protected names or artwork on any merchandise.

Licensed vendors producing merchandise for external organizations and businesses will be required to pay a royalty fee for the use of any of the College's protected terms or official artwork. Licensed vendors producing merchandise for use by internal departments, offices and student groups will not be subject to royalty fees.

The College has partnered with Learfield Licensing Partners to assist in the management of the Licensing and Trademark Enforcement Program. Learfield Licensing Partners is responsible for processing license applications, coordinating artwork approvals, collecting royalty payments and enforcing our trademarks.

CURRENT ART SHEET

MARIETTA COLLEGE			VERBIAGE			
Established: 1835	Nickname: Pioneers	Current Revision Date: February 2023	Marietta College	Putnam The Pio	Ban Johnson Arena	Erwin Tower
Location: Marietta, Ohio	Conference: Ohio Athletic Conference		Marietta College Pioneers	Etta Express	The BanJo	The Long Blue Line
			Marietta Pioneers	PioNation	Don Drumm Stadium	The Rock
			Marietta	#PioNation	Don and Sue Schaly Field at Pioneer Park	Doo Dah Day
			Pioneers	Pioneer		
Uncoated Navy Blue	Coated Navy Blue	Flat Gray	Silver	White		
PANTONE 295U	PANTONE 281C	PANTONE COOL GRAY 3	PANTONE 877	WHITE		
* Approved College colors or the PANTONE® colors listed on this page must be used. The colors on this page are not intended to match PANTONE® color standards, refer to the current editions of the PANTONE® color publications. PANTONE® is a registered trademark of PANTONE, Inc.						

Institutional Marks



Athletic Marks



Athletic Word Marks



Alternate Word Marks



Baseball Marks



School Seal



Additional Pertinent Information

- College seal permitted on products for resale (limited use)
- No alterations or overlaying graphics to seal permitted
- College licenses consumables (must have expiration date on packaging)
- College licenses health and beauty products
- College permits numbers on products for resale
- Baseball marks must be on baseball related products or carry the verbiage "Marietta College Baseball" or "Etta Express" or have baseball imaging and/or graphics.
- Mascot caricatures permitted
- Cross licensing with other marks may be permitted with an additional agreement
- No use of current players' name, image or likeness is permitted on commercial products in violation of NCAA rules and regulations
- No references to alcohol, drugs, or tobacco related products may be used in conjunction with College marks.

03/07/2023

LICENSING PROGRAM AT A GLANCE

LICENSING AND APPROVAL PROCESS

All merchandise that displays any of Marietta College’s protected terms must be produced by a vendor that is an approved licensee through Learfield Licensing Partners. Once licensed, vendors must submit proofs of all merchandise designs through the Learfield Trademarx Online system to ensure they meet Marietta College brand standards. Vendors will generally be notified within one business day if their artwork is approved or requires revision.

It takes approximately two weeks for a vendor to become an approved licensee. After approval, vendors may access the official Marietta College artwork and begin designing merchandise.

Due to the time associated with application, you may find it easier to work with a vendor that is already licensed for Marietta College. All merchandise produced through this process must contain the “officially licensed collegiate product” label on the item or packaging. Licensed vendors will receive this label and instructions for use when they become licensed.

LICENSED VENDORS

Only licensed vendors may be used to produce merchandise. Due to the time associated with application, you may find it easier to work with a vendor that is already licensed for Marietta College. The Marietta College Office of Strategic Communications & Marketing maintains relationships with many highly qualified vendors with licenses. Marietta College encourages faculty, staff and students to order custom merchandise through the Office of Strategic Communications & Marketing for this reason.

All merchandise produced through this process must contain the “officially licensed collegiate product” label on the item or packaging. Licensed vendors will receive this label and instructions for use when they become licensed.

WHAT IS PROTECTED

Through the right of first use and federal registration, Marietta College maintains several protected terms. Only approved licensees will be able to produce, display and distribute merchandise bearing these terms and marks.

Protected Names

- Marietta College (requires ™)
- Marietta College Pioneers (requires ™)
- Pioneers (requires ™)
- Marietta [followed by sport/club/organization name or 1835] (requires ™)
- Any combination of the above

Official artwork/logos are available to licensed vendors through the Learfield Trademarx Online system. Logos are not required to be used on merchandise.

- Marietta College logos (one primary, one secondary academic) - requires ™
- Marietta College athletics logos (one primary, wordmark) - requires ™
- Marietta College Baseball MC (VERY RESTRICTED USAGE) - requires ™

REQUIREMENTS

In almost all merchandise applications, the inclusion of the appropriate trademark symbol is required. The only exceptions are the following:

- If the trademark symbol would be so small that it could not be read, you may omit it and attach a label stating that the Marietta College logo is a trademark of Marietta College.
- If the merchandise is extremely high quality (e.g., gold or other precious metals, crystal), you may omit the trademark symbol and attach a label stating that the Marietta College logo is a trademark of Marietta College.
- The trademark may be omitted on official team uniforms.

COLOR, DESIGNS AND FONTS

Protected names and marks may only be displayed in the colors listed below. Merchandise bearing protected names or marks may only be produced in the colors listed below:

- navy blue (no other variations of blue)
- gray
- white
- black

It is important to note that ONLY solid colors are to be applied when using our artwork or any of our protected names. The following may not be used:

- patterns (stripes, polka dots, splatter, etc.)
- prints (zebra, camouflage, plaid, etc.)
- tie-dye
- gradient fills

When not using Marietta College's official artwork, the use of drop art is permitted.

EXCEPTIONS

Recognized campus groups and organizations affiliated with a national organization may use the national organization's logos and/or colors on merchandise in conjunction with the protected terms. The name or logo of the national organization must be included on the merchandise. Marietta College's identity standards must still be met if using the College's official artwork. All protected terms listed above may be in the national organization's colors scheme, provided official artwork is not used.

CONTACT

Office of Strategic Communications & Marketing

Executive Director
740.376.4408

Director of Creative Services
740.376.4715

Publications Coordinator
740.376.4717

APPROVAL PROCESS

If a job is produced through the Office of Strategic Communications & Marketing, then it meets the guidelines set forth in this document and will receive an approval number for the vendor responsible for producing the job.

If for some reason a department produces a piece that carries the Marietta College logo, but has not been produced by Strategic Communications & Marketing, then that job will need to be approved by Strategic Communications & Marketing. The person or department developing a job needs to submit a copy of the project to Strategic Communications & Marketing in person or by email. The project will then be reviewed by the Strategic Communications & Marketing staff (to ensure the logos and colors are correct) and will be either returned for adjustments to be made or approved and assigned an approval number. An approval number is required before a vendor may begin working on that job. The approval process is not intended to slow down the production of a job and it will be done in as timely a manner as possible.

TRADEMARK INFORMATION

Marietta College's visual identity marks are currently in the process of being registered with the U.S. Patent and Trademark Office. This means that:

- Neither the College's marks or approximations may be used to identify entities other than Marietta College.
- The College's rights to revenue generated by the commercial use of its marks is protected.
- The College's marks cannot be altered or used inappropriately without jeopardizing legal protective status.
- Marks, when used on apparel, should be displayed with the "TM" symbol, indicating trademark status.

MERCHANDISING

The College presents a wide variety of merchandise to students and alumni. The primary hub for Marietta College merchandise is the College Bookstore, which has developed strategies for incorporating the College's visual identity into its merchandise. Campus departments, offices and program areas may also order merchandise for the audiences that they serve. Although these items are often prepared according to the prevailing fashion style or vogue, most suppliers are capable of preparing customized items to match Marietta College's visual identity. While additional production costs may sometimes result, **vendors must always reproduce our official visual identity marks as designed and match PMS 281 or PMS 295 exactly (for printed materials) or as closely as possible for other merchandise where PMS matching capabilities do not exist (usually Navy Blue).**

To protect the trademarks of the College, **all items** bearing Marietta College's name or logos must be officially licensed and approved. The Office of Strategic Communications & Marketing is responsible for coordinating the College's licensing and trademark program. This office **must approve all merchandise bearing the name and/or symbols of the college prior to manufacturing or distribution.** The College strongly suggests that when ordering items (such as mugs, keychains, shirts and pens) you do so through the Office of Strategic Communications & Marketing and by contacting the Director of Printing and Production (ext. 4727). The Office is prepared to handle such requests and in many cases can save the client money by taking bids from multiple merchandising vendors. Camera-ready art is available online at www.marietta.edu/branding to equip vendors to produce their merchandise according to Marietta's standards.

The Office of Strategic Communications & Marketing will be the sole judge of acceptability and reserves the right to grant approval of uses and designs that may deviate from these guidelines.

NOTE TO VENDORS

The visual identity marks depicted in this manual are trademarks of Marietta College. All graphic standards and restrictions outlined in this manual apply to the production of all merchandise—whether purchased by the College or by outside funding. Design alterations or substitutions are strictly prohibited without the express written consent of the College Art Director.

All jobs produced at Marietta College that carry the official logo need to have an approval number. **Without this number, Marietta College reserves the right to reject delivery of, and payment for, materials containing unauthorized or incorrect usages of the Marietta College visual identity marks, including the College logo, seal and athletic logos.**

HOW TO OBTAIN VISUAL IDENTITY MARKS

Marietta College's visual identity marks are available instantly online at www.marietta.edu/branding with a Marietta College login and password. Or you may request any of the production-ready files through the Office of Strategic Communications & Marketing. (Please allow 1-2 working days for your request.)

Contact Information:

Director of Creative Services
Marietta College
215 Fifth Street
Marietta, OH 45750
ext. 4715 (on campus)
740.376.4715 (off campus)

Marietta College Logos Available Online

- Logos will be available in black, gray, PMS 281, PMS 295 and white.
- Logos will be available as .eps, .jpg, .gif, .pdf and .ai file formats.

Marietta College Athletic Marks

Artwork is available at www.marietta.edu/branding, or contact the Office of Strategic Communications & Marketing at ext. 4715 (on campus) or at 740.376.4715 (off campus).

